

BM200 Datasheet

BLE Pass-through Module Bluetooth 5.0

version 03

2021/7/21

Whayu industrial co. ltd

TEL: 03-5714225

No.326, Sec. 2, Kung Tao 5 Road., Hsinchu City
30070, Taiwan (R.O.C.)

Table of Contents

Table of Contents	1
<i>Revision History</i>	2
<i>Related Documents</i>	2
<i>Overview:</i>	3
<i>Feature</i>	3
<i>PIN Configurations:</i>	3
<i>Descriptions of functional PINs</i>	4
<i>Electrical Characteristics</i>	5
<i>Radio Characteristics</i>	6
<i>Digital IO Pin DC Characteristics</i>	6
<i>Power Consumption</i>	6
<i>Antenna Peak gain & Efficiency</i>	6
<i>Antenna 2D Radiation Pattern Results</i>	7
<i>Mechanical Dimensions</i>	8
<i>Layout Footprint</i>	8
<i>Application Schematic</i>	9
<i>Layout Guideline</i>	9

Revision History

Date	Release	Author	Description
2021/2/5	R01	LL/JW	First released
2021/6/23	R02	LL/JW	
2021/7/21	R03	LL/JW	Add FCC Statement

Related Documents

Date	Author	Document(s)

Overview:

BM200 is Bluetooth 5.0 Low Energy serial pass-through module based on ultra-low-power Realtek RTL8762C SOC with built-in high performance PCB antenna. Just simply connect BM200 module to MCU by using UART interface, focus on MCU firmware development and save time on BLE stack and hardware development, simple and neat.

Feature

Supports Bluetooth 5.0 Core Specification

Supports LE_1M, LE_2M, LR2 and LR8

ARM Cortex-M4 with floating-point unit (Maximum 40MHz)

Total 160KB SRAM

4K bits eFuse for manufacturer use

Embedded 2Mbits flash

Supports AES128/192/256 encrypt /decrypt engine

Built-in PCB antenna

PIN Configurations:

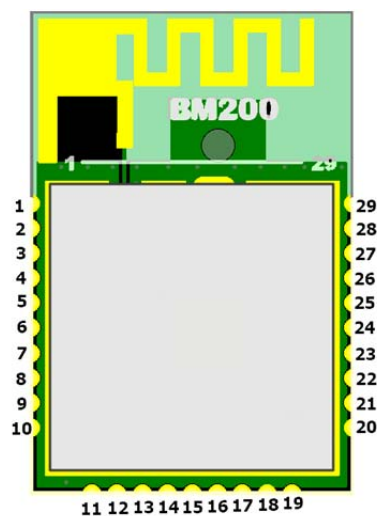

BM200 PIN Configurations

Descriptions of functional PINs

PIN NO.	PIN NAME	TYPE	DESCRIPTIONS
1	GND	POWER	GROUND
2	NRESET	I	Hardware reset pin; low active
3	P4_3	IO	General purpose IO; 8mA driving capability. With wakeup function. With internal strong/weak pull-up and pull-down.
4	P4_2	IO	General purpose IO; 8mA driving capability. With wakeup function. With internal strong/weak pull-up and pull-down.
5	P4_1	IO	General purpose IO; 8mA driving capability. With wakeup function. With internal strong/weak pull-up and pull-down.
6	P4_0	IO	General purpose IO; 8mA driving capability. With wakeup function. With internal strong/weak pull-up and pull-down.
7	P0_6	IO	General purpose IO; 8mA driving capability. With wakeup function. With internal strong/weak pull-up and pull-down.
8	P0_5	IO	General purpose IO; 8mA driving capability. With wakeup function. With internal strong/weak pull-up and pull-down.
9	VDDIO	POWER	Supply 1.8V~3.3V power for digital IO PAD VDDIO should be less than or equal to VDD
10	GND	POWER	GROUND
11	P0_4	IO	General purpose IO; 8mA driving capability. With wakeup function. With internal strong/weak pull-up and pull-down.
12	P0_3/Power on trap	IO	LOG_UART TX. Power on trap: Pull-up for normal operation Pull-down to bypass executing program code in flash (PAD internal pull-up by default)
13	P0_2	IO	General purpose IO; 8mA driving capability. With wakeup function. With internal strong/weak pull-up and pull-down.
14	P0_1	IO	General purpose IO; 8mA driving capability. With wakeup function. With internal strong/weak pull-up and pull-down.
15	P0_0	IO	General purpose IO; 8mA driving capability. With wakeup function. With internal strong/weak pull-up and pull-down.
16	P1_0/SWDIO	IO	General purpose IO; 8mA driving capability. With wakeup function.

			With internal strong/weak pull-up and pull-down. SWDIO (default).
17	P1_1/SWDCLK	IO	General purpose IO; 8mA driving capability. With wakeup function. With internal strong/weak pull-up and pull-down. SWDCLK (default).
18	GND	POWER	GROUND
19	VDD	POWER	Supply 1.8V~3.3V power for Module
20	GND	POWER	GROUND
21	P3_3	IO	General purpose IO; 8mA driving capability. With wakeup function. With internal strong/weak pull-up and pull-down.
22	P3_2	IO	General purpose IO; 8mA driving capability. With wakeup function. With internal strong/weak pull-up and pull-down.
23	P3_1/UART_RX	IO	General purpose IO; 8mA driving capability. With wakeup function. With internal strong/weak pull-up and pull-down. HCI_UART_RX (default).
24	P3_0/UART_TX	IO	General purpose IO; 8mA driving capability. With wakeup function. With internal strong/weak pull-up and pull-down. HCI_UART_TX (default).
25	32K_XI	A/IO	32k crystal input or external 32k clock input (optional) Pin share as GPIO when external 32k is not used.
26	32K_XO	A/IO	32k crystal input or external 32k clock input (optional)÷ Pin share as GPIO when external 32k is not used.
27	P2_2	IO	General purpose IO; 8mA driving capability. With wakeup function. With internal strong/weak pull-up and pull-down. AUXADC input 2.
28	P2_3	IO	General purpose IO; 8mA driving capability. With wakeup function. With internal strong/weak pull-up and pull-down. AUXADC input 3.
29	GND	POWER	GROUND

Electrical Characteristics

Parameter	Minimum	Typical	Maximum	Units
Storage Temperature	-55		+125	°C
Operation Temperature	-30		+80	°C
VDD	1.8	3	3.6	V
VDDIO (note: VDDIO ≤ VDD)	1.8	-	3.6	V

Radio Characteristics

Condition: VDD=3V, VDDIO=3V, ambient temperature=25°C

Parameter	Minimum	Typical	Maximum	Units
Frequency Range	2402	-	2480	MHz
Sensitivity PER $\leq 30.8\%$ (LE2M/LE1M/LR2/LR8)	-93/-96/-99/-104	-	-	dBm
Maximum Input level	-	-	-1	dBm
Maximum Output Power			7	dBm

Digital IO Pin DC Characteristics

Parameter	Condition	Min	Typical	Max
Input high voltage (V)	VDDIO=3.3V	2	3.3	3.6
Input low voltage(V)	VDDIO=3.3V	-	0	0.9
Output hi voltage(V)	VDDIO=3.3V	2.97	-	3.3
Output lo voltage(V)	VDDIO=3.3V	0	-	0.33

Power Consumption

Condition: VDD=3V, VDDIO=3V, ambient temperature=25°C

Power Mode	Always on registers	32K RCOSC	Retention SRAM	CPU	Wakeup Method	Current Consumption(typ.)
Power Down	ON	OFF	OFF	OFF	GPIO	450nA
Deep LPS	ON	ON	Retention	OFF	GPIO,TIMER	2.5uA
Active RX Mode						7.3mA
Active TX Mode						11.3mA

Antenna Peak gain & Efficiency

Frequency (MHz)	Peak Gain (dBi)	Efficiency (%)
2400	1.83	46
2450	0.37	44
2500	0.96	43

Antenna 2D Radiation Pattern Results

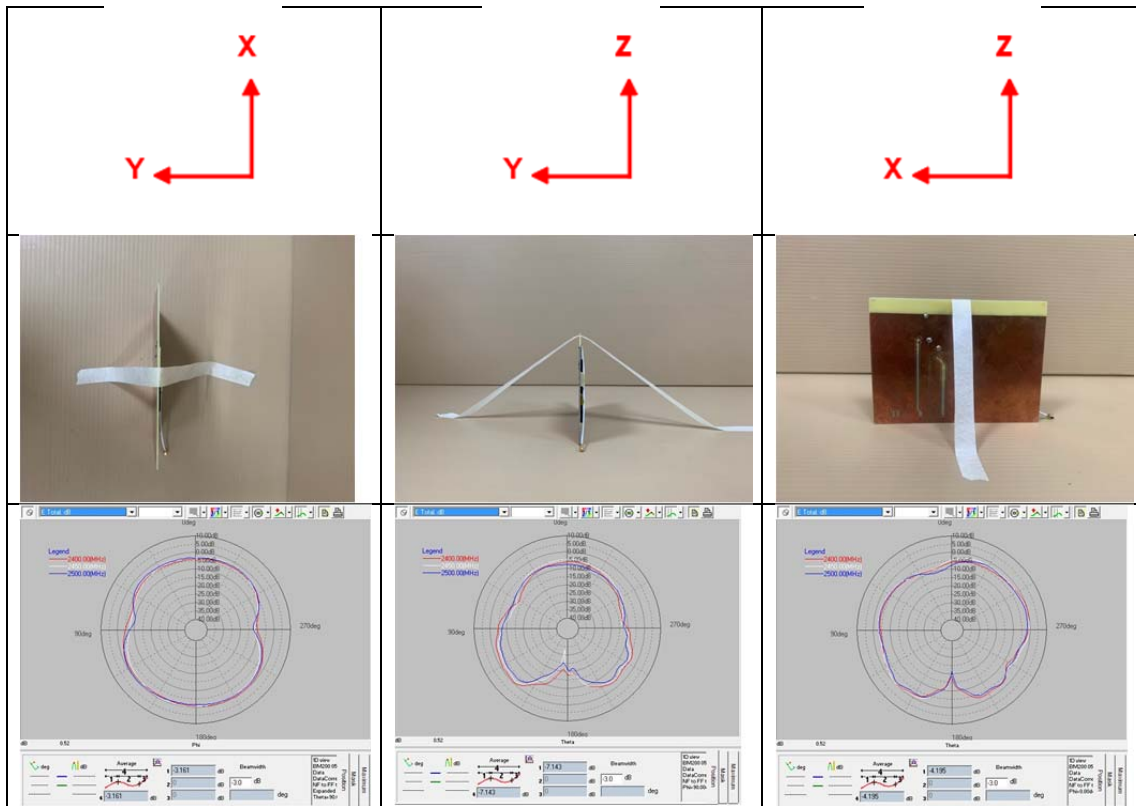

Mechanical Dimensions

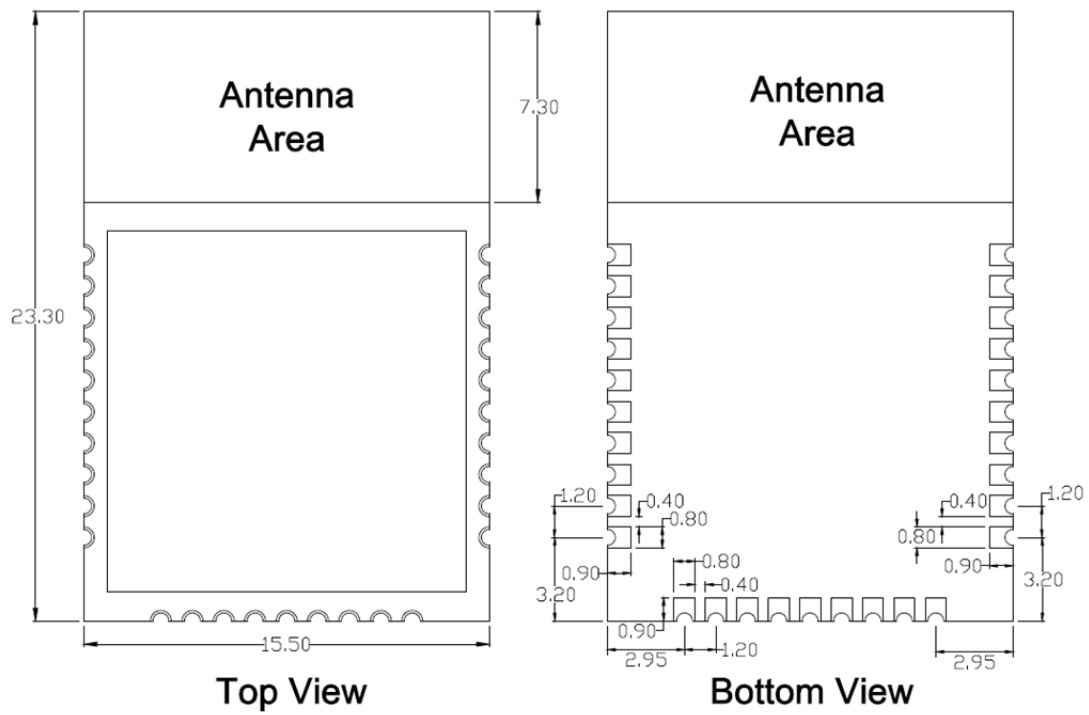

Layout Footprint

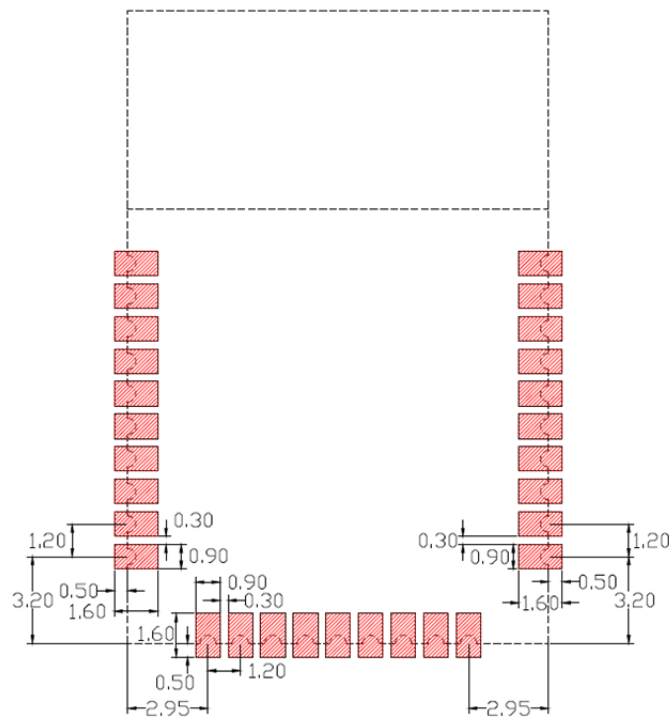

Application Schematic

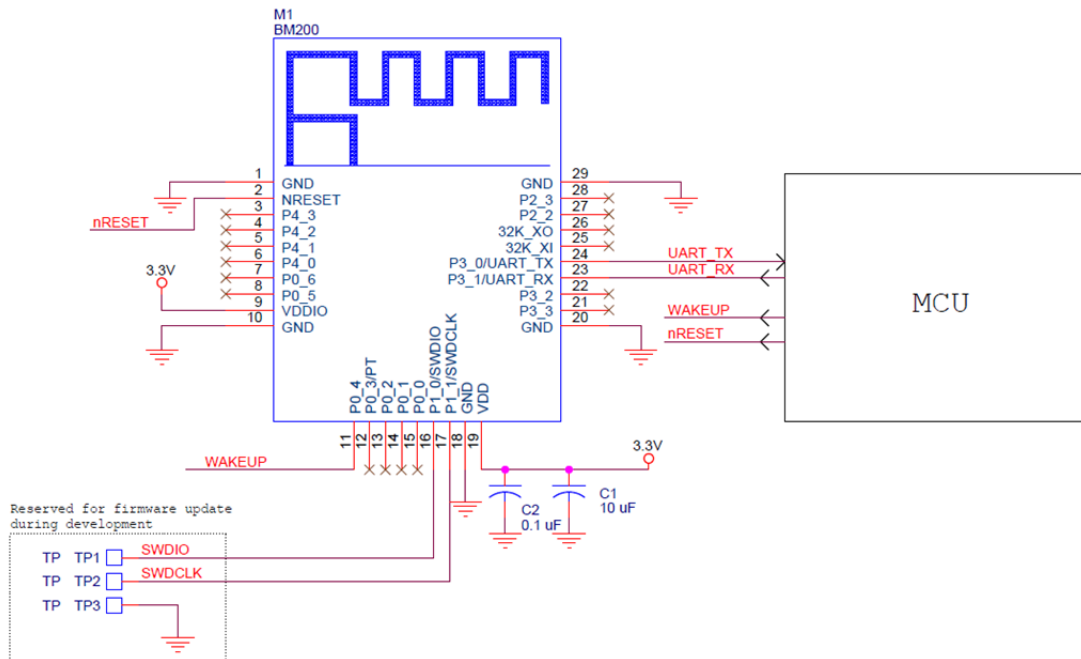

Layout Guideline

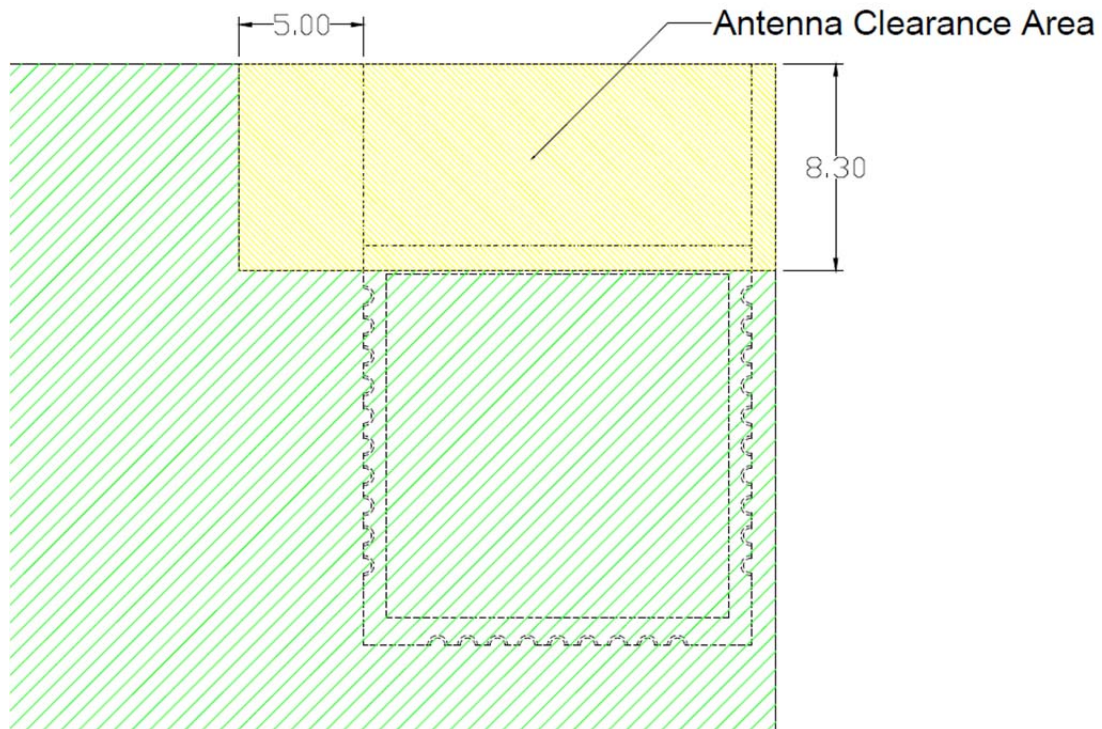

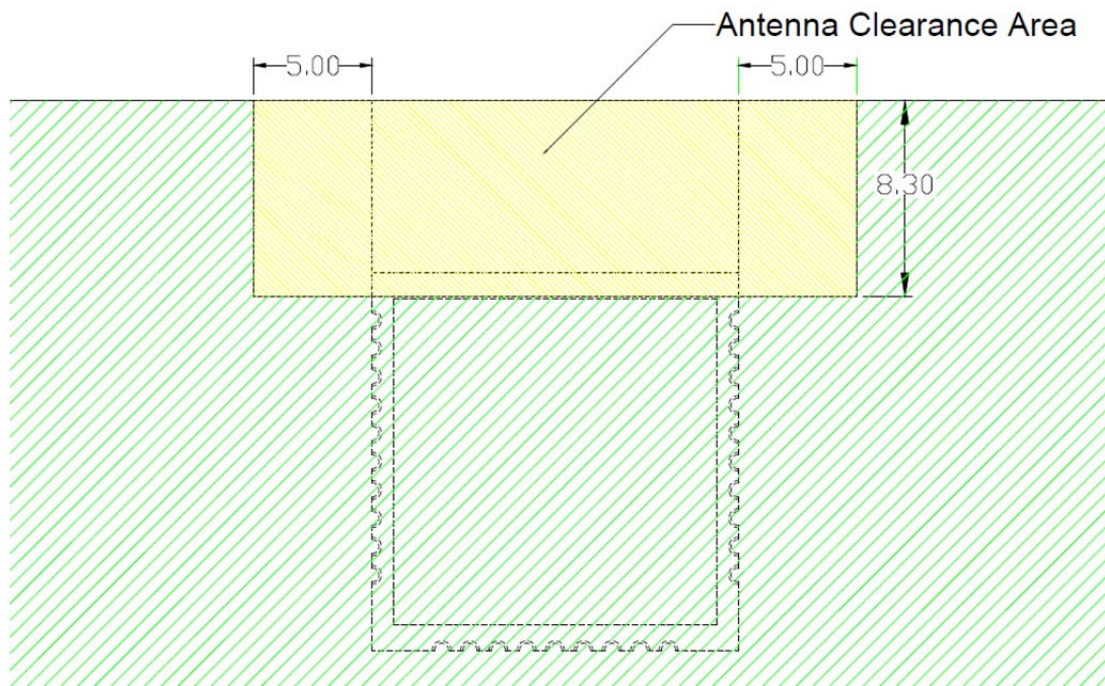

Federal Communication Commission Interference Statement

This equipment has been tested and found to comply with the limits for a Class B digital device, pursuant to Part 15 of the FCC Rules. These limits are designed to provide reasonable protection against harmful interference in a residential installation. This equipment generates, uses and can radiate radio frequency energy and, if not installed and used in accordance with the instructions, may cause harmful interference to radio communications. However, there is no guarantee that interference will not occur in a particular installation. If this equipment does cause harmful interference to radio or television reception, which can be determined by turning the equipment off and on, the user is encouraged to try to correct the interference by one of the following measures:

- Reorient or relocate the receiving antenna.
- Increase the separation between the equipment and receiver.
- Connect the equipment into an outlet on a circuit different from that to which the receiver is connected.
- Consult the dealer or an experienced radio/TV technician for help.

FCC Caution: Any changes or modifications not expressly approved by the party responsible for compliance could void the user's authority to operate this equipment.

This device complies with Part 15 of the FCC Rules. Operation is subject to the following two conditions: (1) This device may not cause harmful interference, and (2) this device must accept any interference received, including interference that may cause undesired operation.

FCC Radiation Exposure Statement:

This equipment complies with FCC radiation exposure limits set forth for an uncontrolled environment. This equipment should be installed and operated with minimum distance **20cm** between the radiator & your body.



BM200 Datasheet

This module is intended for OEM integrator. This module is only FCC authorized for the specific rule parts listed on the grant, and that the host product manufacturer is responsible for compliance to any other FCC rules that apply to the host not covered by the modular transmitter grant of certification. The final host product still requires Part 15 Subpart B compliance testing with the modular transmitter installed.

Additional testing and certification may be necessary when multiple modules are used.

USERS MANUAL OF THE END PRODUCT:

In the users manual of the end product, the end user has to be informed to keep at least 20cm separation with the antenna while this end product is installed and operated. The end user has to be informed that the FCC radio-frequency exposure guidelines for an uncontrolled environment can be satisfied.

The end user has to also be informed that any changes or modifications not expressly approved by the manufacturer could void the user's authority to operate this equipment.

This device complies with Part 15 of FCC rules. Operation is subject to the following two conditions: (1) this device may not cause harmful interference and (2) this device must accept any interference received, including interference that may cause undesired operation.

LABEL OF THE END PRODUCT:

The final end product must be labeled in a visible area with the following " Contains TX FCC ID: RUK-BM200 ".

This device complies with Part 15 of FCC rules. Operation is subject to the following two conditions: (1) this device may not cause harmful interference and (2) this device must accept any interference received, including interference that may cause undesired operation.

Ant list

Ant.	Brand	Model Name	Antenna Type	Connector	Gain (dBi)
1	M gear	BM200	PCB Antenna	I-PEX	1.83